

INFORMATION TABLE

Profile type	Visible element [mm]	Joint width [mm]	Base width [mm]	Installation height [mm]	Material type	Maximum load [kN]	Horizontal/Vertical compensation [mm]
EL 50.8.20	50	50	175	20	Aluminum, modified PVC	30	16(±8) 16(±8)

CONECTO EL 50.8.20  
VIEW

CONECTO EL 50.8.20  
SECTION

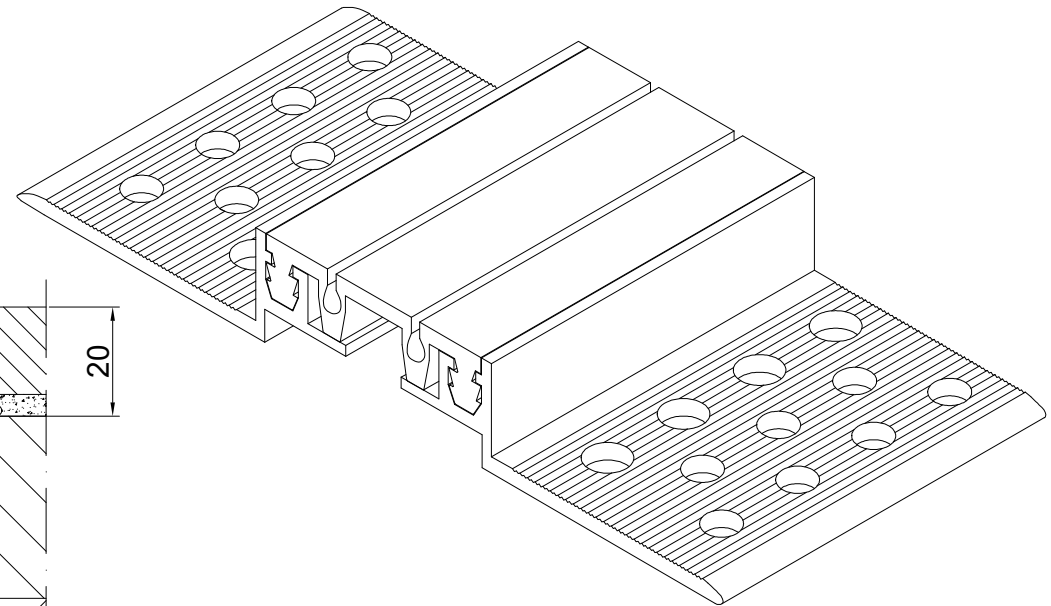
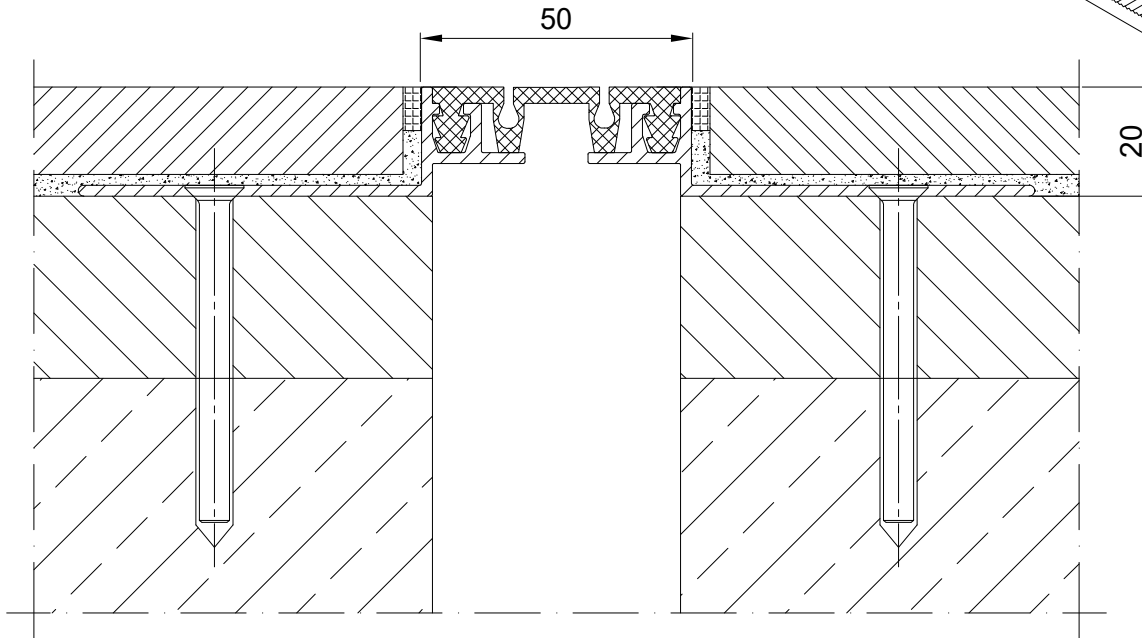

Expansion joint Conecto  
Elasto 50.8.20

Conecto Profiles Sp. z o.o.  
ul. Przemysłowa 39  
61-541 Poznań  
www.conecto-profiles.com



ROZMIAR / SIZE A3	SKALA / SCALE 1:1	Wszystkie wymiary podano w [ mm ] All dimensions in [ mm ]
----------------------	----------------------	---

PROJEKT	PROJECT	ZŁOŻENIE	SUB ASSEMBLY	RYSunEK	DRAWING	ARKUSZ SHEET	VER REV
--		--		01		1 Z OF 1	