

INFORMATION TABLE

Profile type	Visible element [mm]	Joint width [mm]	Base width [mm]	Installation height [mm]	Material type	Maximum load [kN]	Horizontal/Vertical compensation [mm]
GA 63.30.35 S	109	84	235	35	Aluminum, PVC, steel	200	60(±30)

CONECTO GA 63.30.35 S  
VIEW

CONECTO GA 63.30.35 S  
SECTION

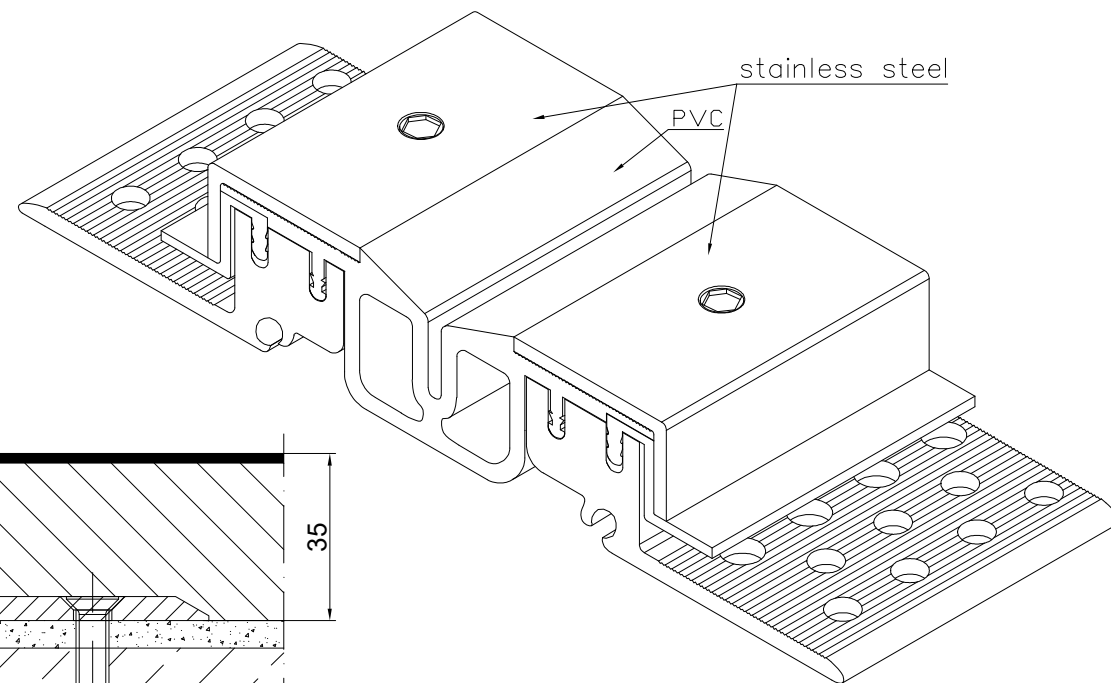
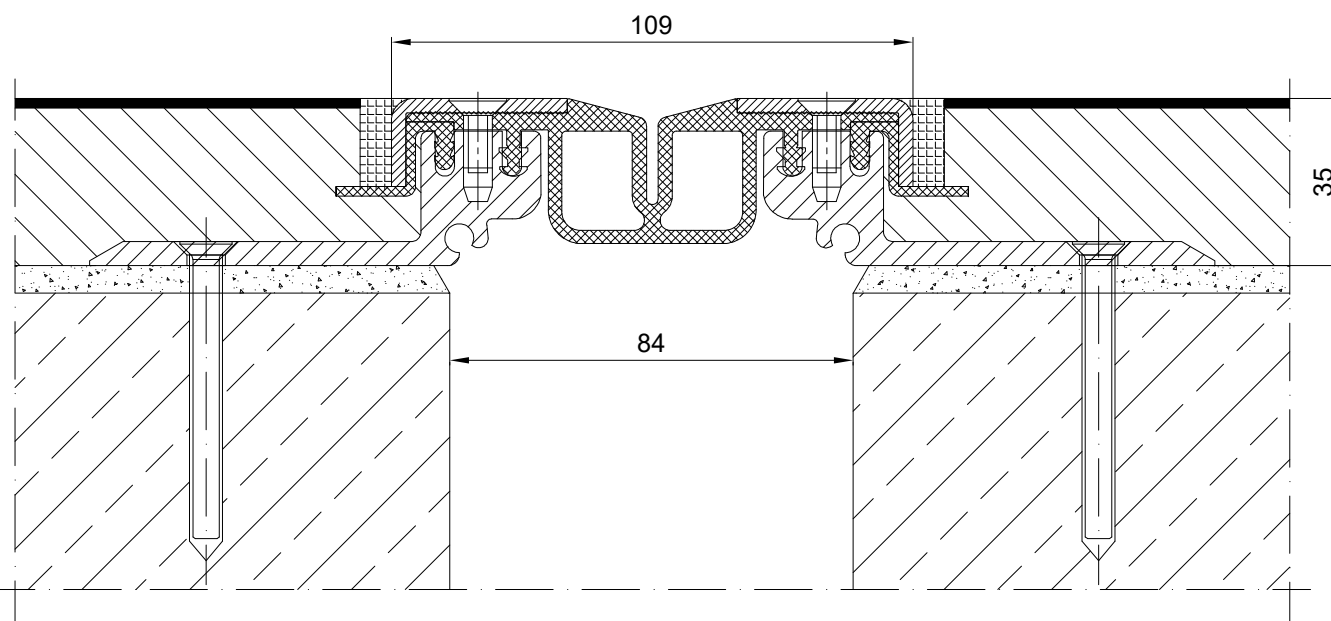

Expansion joint  
Conecto Park GA 63.30.35 S

Conecto Profiles Sp. z o.o.  
ul. Przemysłowa 39  
61-541 Poznań  
www.conecto-profiles.com



ROZMIAR / SIZE A3	SKALA / SCALE 1:1	Wszystkie wymiary podano w [ mm ] All dimensions in [ mm ]
----------------------	----------------------	---

PROJEKT	PROJECT	ZŁOŻENIE	SUB ASSEMBLY	RYSUNEK	DRAWING	ARKUSZ SHEET	WER REV
--	--	--	--	01	01	1 Z OF 1	